

Send

Gifts to share

When someone gives you a gift, you say “thank you.” God has given you many gifts and talents to share with others.

Draw a way you can share God’s gifts to you with others.

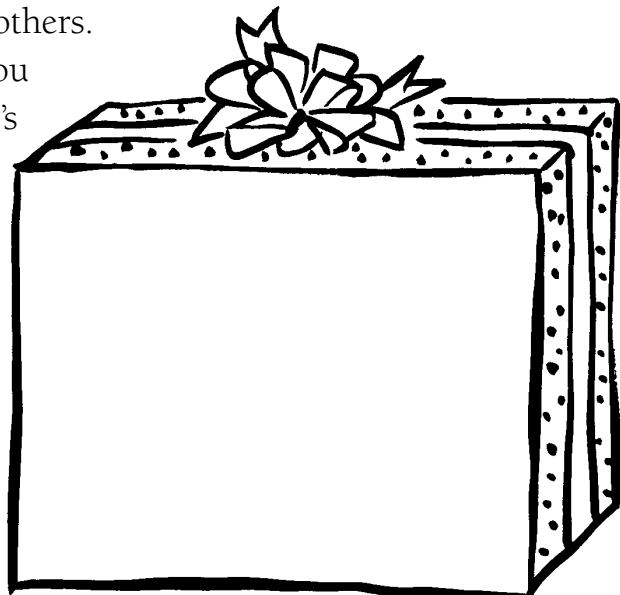

Plan how you can do what you drew.

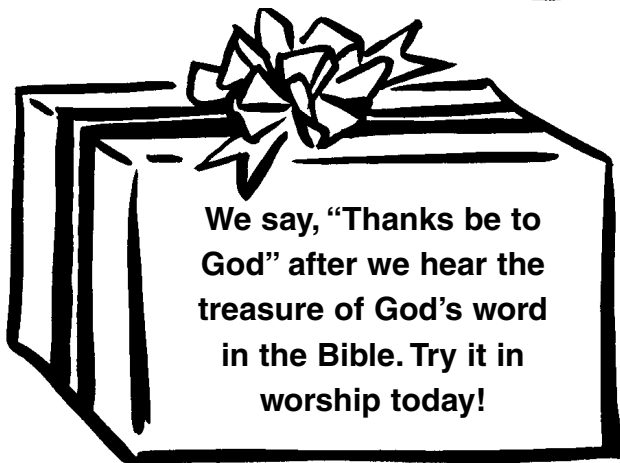

This week

Make a family list of the many daily gifts we receive from God.

Kids Celebrate

Lectionary 25

gather

Welcome to worship. Have you ever gone on a treasure hunt? Use your finger to trace the lines. The SERVE GOD path leads to the best treasure. Our possessions and our money are not treasures to store up or hide. They are gifts from God. Serving God is the real treasure in life.

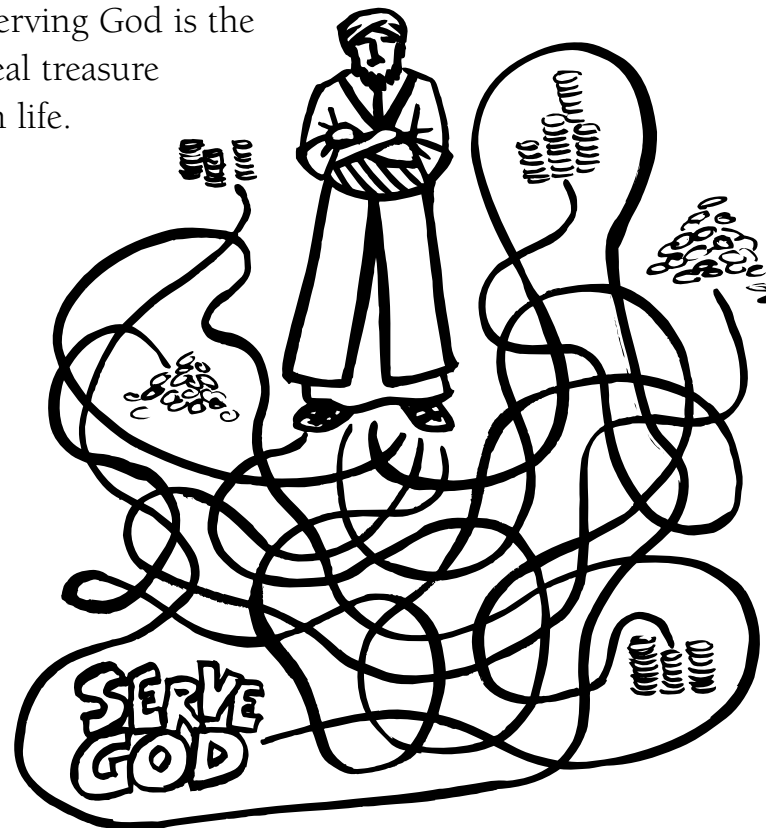

A mixed-up story

Luke 16:1-13

Today's gospel is a mixed up story. Even though the manager was losing money for the rich man, he was not punished. He was praised for what he did! Jesus says, "Whoever is faithful in a little is also faithful in much; and whoever is dishonest in a very little is also dishonest in much." Our goal is to be faithful to God with all of our money, time, and energy.



We can serve God instead of serving our money. If we worry about making money instead of serving God, our lives become as mixed up as the manager's story.

Find and circle five money things that would not fit in a story set in Bible times.



*You are our
treasure, Lord.*

Amen

Decorate for the Seasons

Did you know that nature has 4 seasons and each season is different? The church year has seasons too but they are a different set of seasons. We are currently in the nature season of fall, and the church season we call the Season after Pentecost. Below are two drawings of a church. Decorate the first one using parts of the nature season of fall. Decorate the second one using parts of the Season after Pentecost. (Hint: use the color green!)

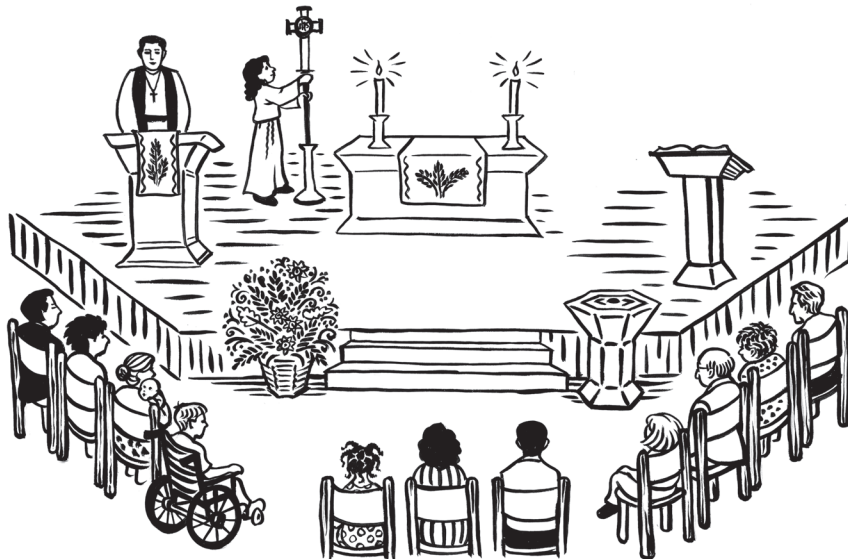
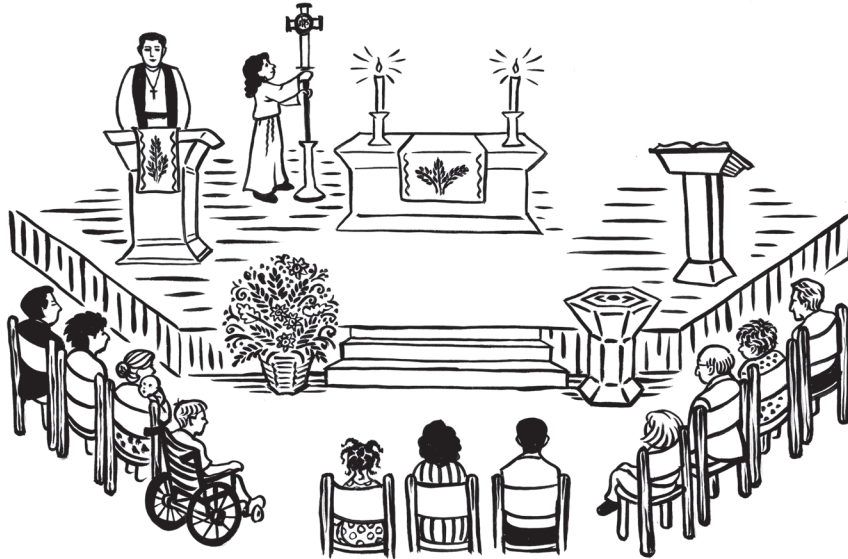

READER

Pentecost 15

- Today is **15th** Sunday after Pentecost.
- Pentecost is a time to learn about the **Lord we worship**.
- In Pentecost, we remember that **worshipping God is more important** than anything else!

Can You Climb This Tree!?

Do you like climbing trees? Try to climb this one! Draw footprints and handprints on the branches that you'd use to scale this big tree.

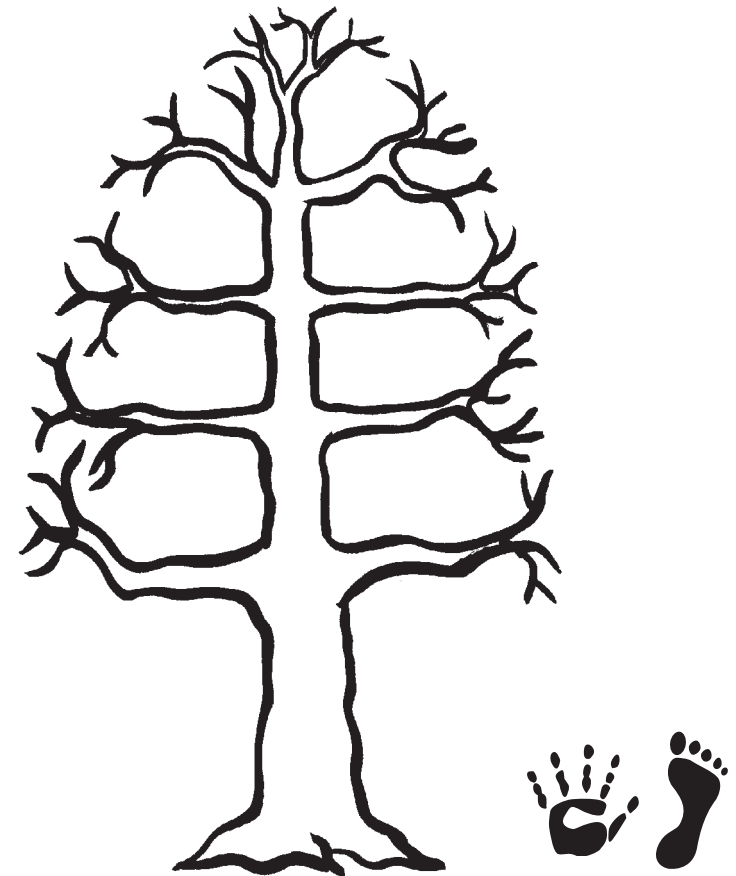

Take Your Pick

It today's memory verse, God tells us that **we cannot serve both God and wealth** (Luke 16:13b). Look at the pairs below and take your pick! Circle the one you would choose.

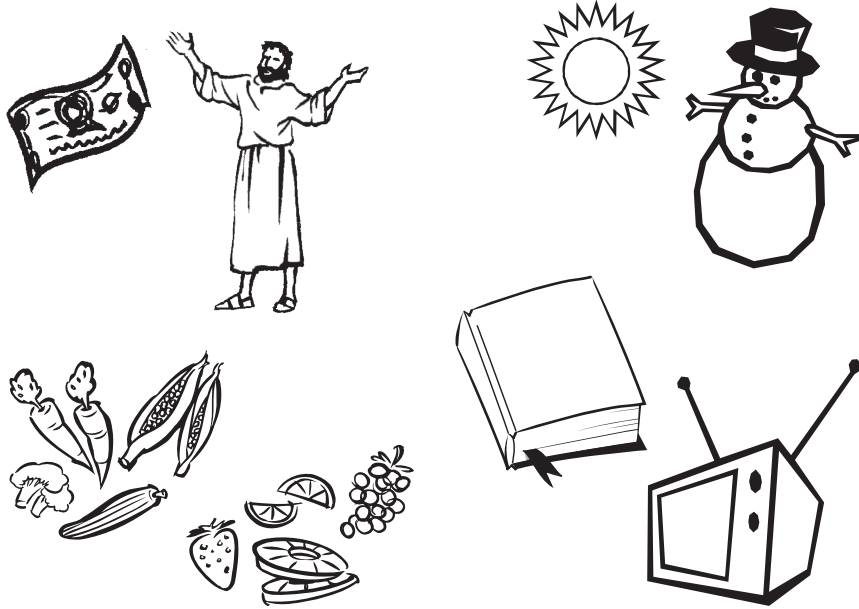

Today's story talks about how we cannot worship both God and money. Go to Exodus 20 and look up the 10 Commandments. Write the first one below:

1. _____

What does it mean to have another God? What are some things that people worship that can take the place of God? List them below.

- 1.
- 2.
- 3.
- 4.
- 5.

If I Had a Million Dollars...

If you were handed \$1,000,000 right now, how would you spend it? In the categories below, break it down and write in how much money you would spend on each.

*Try to make sure that all of these values add to one million!

- Giving it to your church: \$ _____
- Going on a luxury vacation for you and your family: \$ _____
- Getting a pet: \$ _____
- Buying books for kids in schools that have no books: \$ _____
- Buying a warm coat for someone in the winter: \$ _____
- Getting a new bicycle: \$ _____
- Going out to the fanciest restaurant in town: \$ _____
- Re-stocking the local food shelf with food for the hungry: \$ _____
- Saving money so you can go to college: \$ _____

Make up your own ways to spend money!

_____ \$ _____

_____ \$ _____

Design Your Own Currency

In today's story, God tells us that we cannot be greedy with our money. Though money can distract us from God, it is also a part of our world. If you could design your own money, what would it look like? Whose face would be on it?

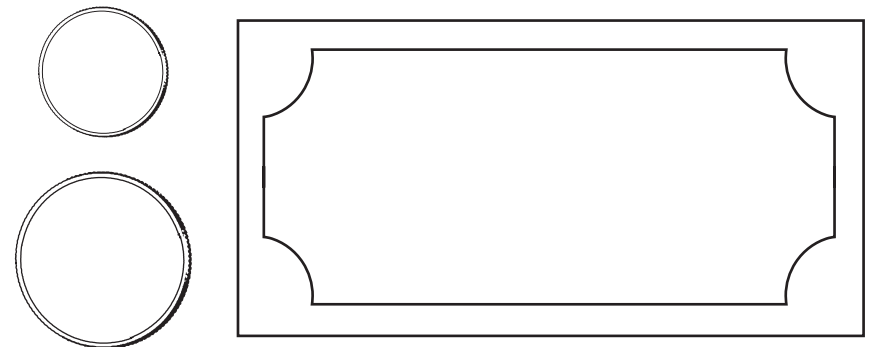

Are you passing the offering plate around during worship today?

Fill this offering plate with money by doing a coin rubbing! First, find a coin and put it under this piece of paper. Then, on a flat surface, use a pencil or crayon to draw lightly on top of the coin. Can you see the designs of the coin!?

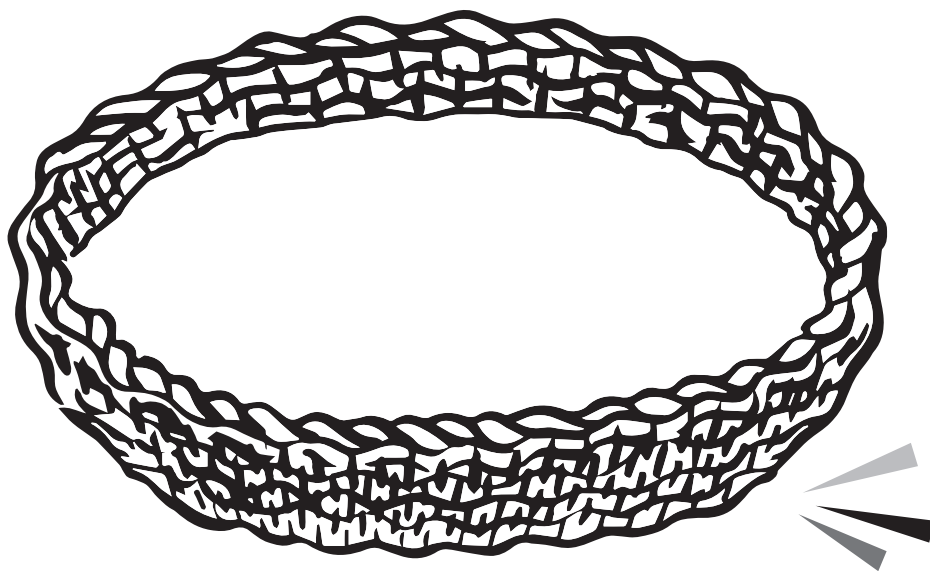

PRE-READER

Pentecost 15

- Today is the 15th Sunday after Pentecost.
- The season of Pentecost goes through the **spring, summer, and fall.**
- During Pentecost, we learn what it means to **worship God.**

Trees provide food for lots of different animals. Match the tree foods below with their eaters.

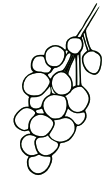
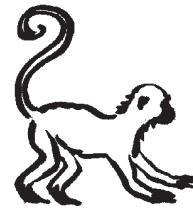



You can't serve God and be greedy serving yourself at the same time.



What are some things in your life that are valuable to you?

Draw them in the home below.

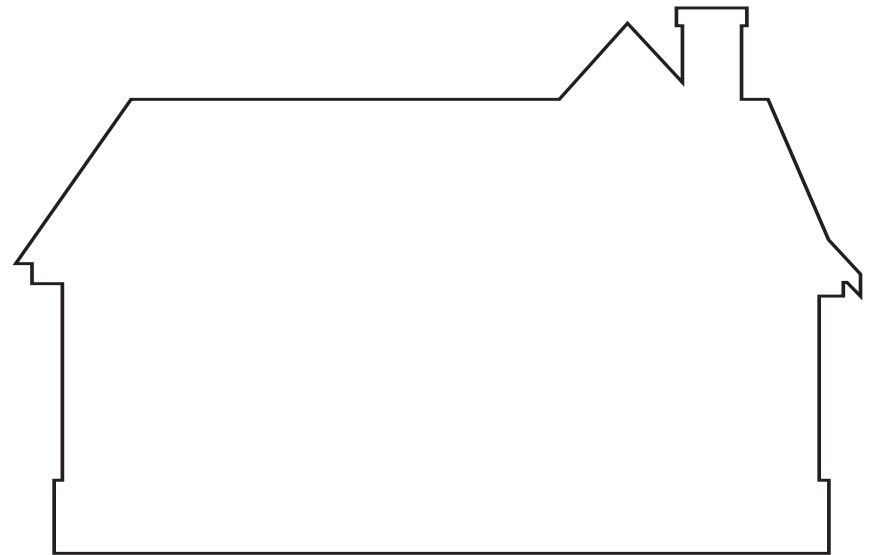

Today's story is about money. If you could design your own money, what would it look like? Whose face would be on it?

